

UOS

RESEARCHER PROFILES

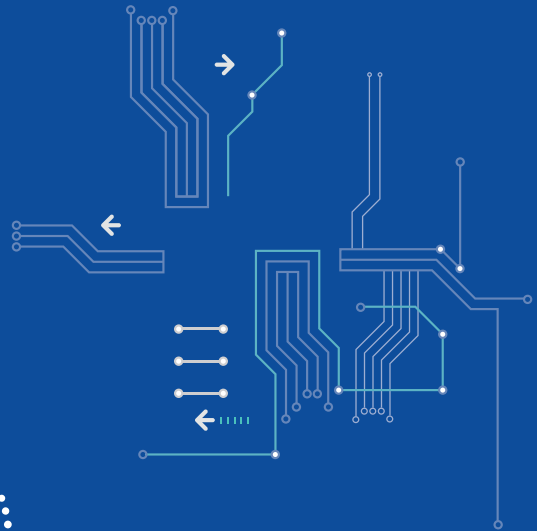

Semiconductor

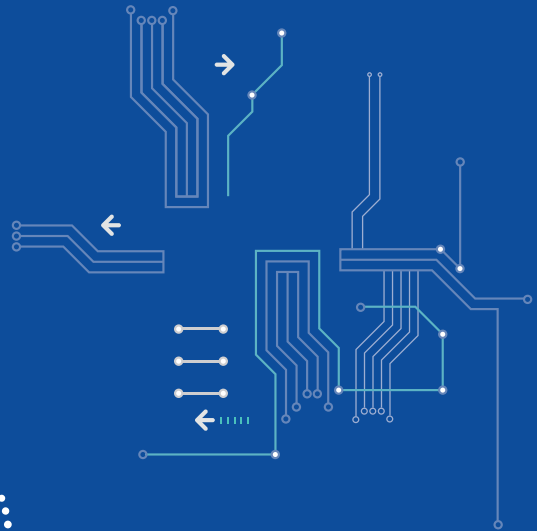
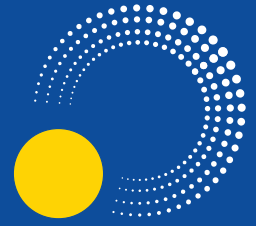

UNIVERSITY OF SEOUL

UOS RESEARCHER PROFILES

Semiconductor

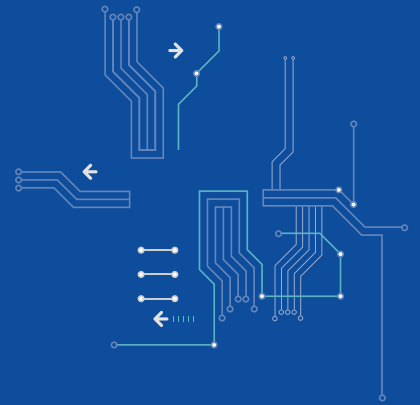

■ Organization

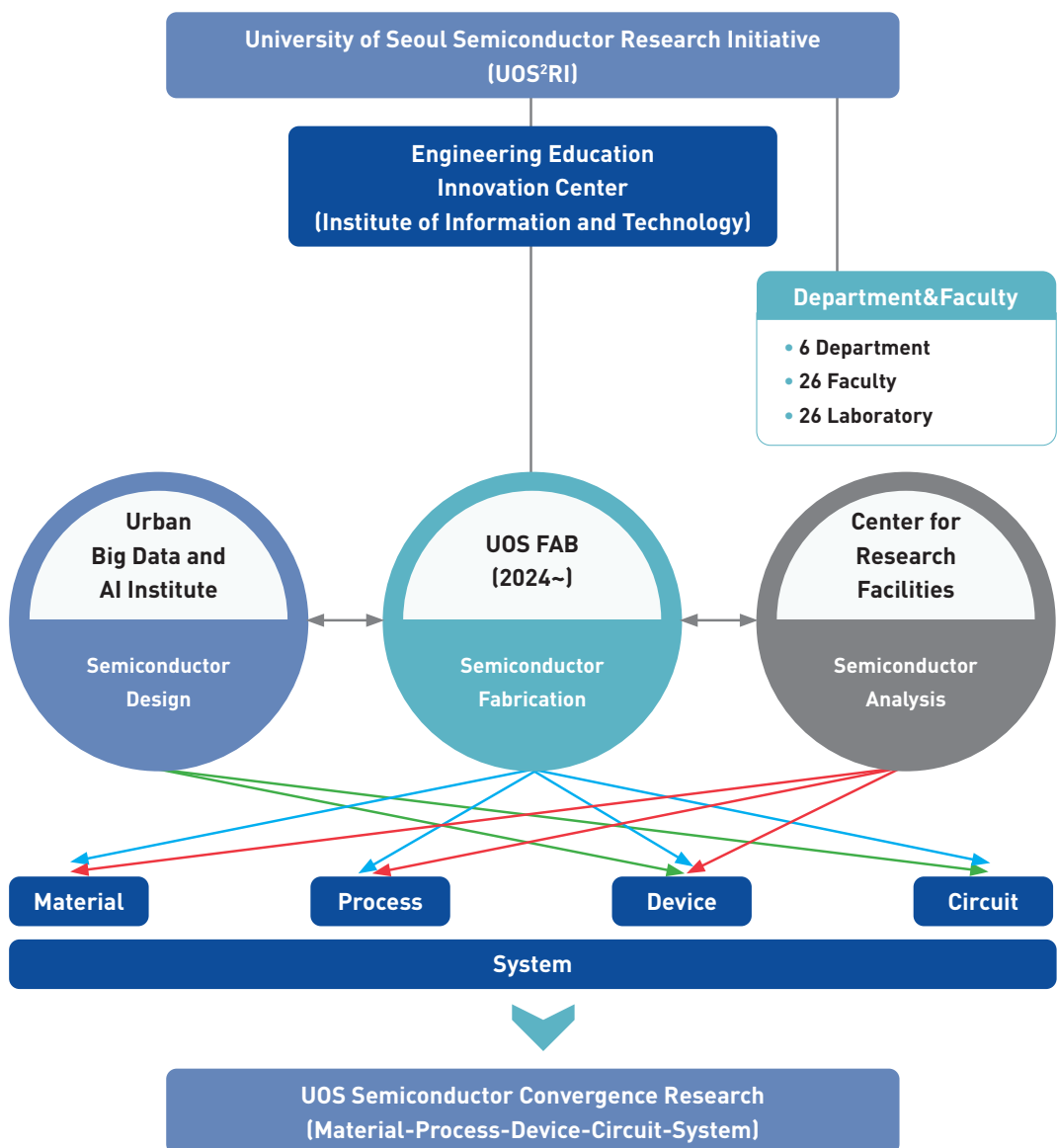

Faculty

Material

03

No.	Faculty	Department	
1	Young Jun Chang	Department of Physics	05
2	Suk Bum Chung	Department of Physics	06
3	Sang-il Kim	Department of Materials Science and Engineering	07
4	Hyun-Sik Kim	Department of Materials Science and Engineering	08
5	Jinhwan Yoon	Department of Chemical Engineering	09
6	Dahin Kim	Department of Chemical Engineering	10
7	Jong Woo Lee	Applied Chemistry	11

Process

12

No.	Faculty	Department	
8	Jung Hyeun Kim	Department of Chemical Engineering	13
9	Ohsung Song	Department of Materials Science and Engineering	14
10	Jae Pil Jung	Department of Materials Science and Engineering	15
11	Byung Jun Jung	Department of Materials Science and Engineering	16
12	Hyosun Lee	Department of Materials Science and Engineering	17
13	TaeWan Kim	School of Advanced Fusion Studies	18
14	Seongah Jeong	School of Advanced Fusion Studies	19

Device

20

No.	Faculty	Department	
15	Dong-Wook Park	School of Electrical and Computer Engineering	21
16	Hyeok Kim	School of Electrical and Computer Engineering	22
17	Yoon Kim	School of Electrical and Computer Engineering	23
18	Jung Hwa Seo	Department of Physics	24
19	Myounggon Kang	School of Advanced Fusion Studies	25
20	TaeWan Kim	School of Advanced Fusion Studies	26
21	Sin-Hyung Lee	School of Advanced Fusion Studies	27

Circuit

28

No.	Faculty	Department	
22	Joongho Choi	School of Electrical and Computer Engineering	29
23	Yongsam Moon	School of Electrical and Computer Engineering	30
24	Moon-Que Lee	School of Electrical and Computer Engineering	31
25	Seung-Hwan Lee	School of Electrical and Computer Engineering	32
26	Minsuk Koo	School of Advanced Fusion Studies	33
27	Min-Jae Seo	School of Advanced Fusion Studies	34



Material

No.	Faculty	Department
1	Young Jun Chang	Department of Physics
2	Suk Bum Chung	Department of Physics
3	Sang-il Kim	Department of Materials Science and Engineering
4	Hyun-Sik Kim	Department of Materials Science and Engineering
5	Jinhwan Yoon	Department of Chemical Engineering
6	Dahin Kim	Department of Chemical Engineering
7	Jong Woo Lee	Applied Chemistry

Young Jun Chang | 장영준 교수



Department: Department of Physics/Smart Cities/Intelligent Semiconductor

Lab: Smart Film Laboratory

Ph.D.: Seoul National University, 2008

Research: Quantum materials and functional thin films

E-mail: yjchang@uos.ac.kr

Homepage: sites.google.com/site/youngjunchanglab

Key Words

2D semiconductor materials, Energy-application materials, Molecular beam epitaxy(MBE), ARPES, APXPS, XMCD, Sputter, Machine-learning, Spectroscopic ellipsometry, CV analysis

Areas of Research

2D Quantum Materials

- Molecular Beam Epitaxy Synthesis of Chalcogenide and Oxide films
- Quantum materials: ARPES/AP-XPS/Synchrotron-based analysis

Semiconductor Technology

- Optical, Electrical, Spectroscopic analysis for 3D NAND DRAM technology
- Defect study of charge trap layer for Flash memory

Energy Application Materials

- E-efficiency: efficient next-generation power transistor(GaN, TCO)
- E-generation: electrochemical catalytic electrode(Ir-compounds, WOx)

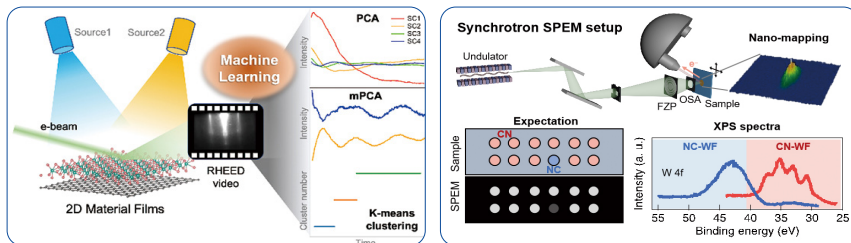

[Machine learning on quantum material growth(left), Synchrotron analysis of 3D NAND structure(right)]

Recent Publications&Projects

- Nano Convergence, "Machine-learning-assisted analysis of TMDC thin-film growth"(2023)
- Applied Surface Science, "Direct observation of trapped charges at ReSe2 and graphene"(2022)
- ACS Nano, "Controlling spin-orbit coupling to tailor type-II Dirac bands"(2022)
- MSIT "Charge-spin ordering and electronic structure dynamics in chalcogenide epitaxial films"(~2025)
- MSIT "Advanced Quantum Material Synchrotron Research Center"(~2025)
- MSIT "Extreme Quantum Functional Material Research Center"(~2030)
- Samsung Electronics Co. "Multi-modal analysis for reliability improvement in CTF devices"(~2024)

Honors&Awards

- [Award] Applied Physics Academic Award, Korean Physical Society(2022)

Suk Bum Chung | 정석범 교수



Department: Department of Physics

La b: Quantum Material Properties Laboratory

Ph.D.: University of Illinois Urbana-Champaign, 2008

Research: Condensed Matter Theory (superconductor, magnetism, topological insulator)

E-mail: sbchung0@uos.ac.kr

Homepage: nsri.uos.ac.kr/faculty

Key Words

Condensed Matter and Statistical Physics, Topological States of Condensed Matter, Superconductor

Areas of Research

Superconductivity in semiconductor/semimetal

- Theory of superconductivity in doped quantum paraelectrics
- Topological multiband s-wave superconductivity in coupled multifold fermions

Spintronics in magnets/superconductor

- Spin transport in 2D magnets
- Vortex effect on spin transport in superconductor
- Phonon-mediated spin transport in quantum paraelectrics

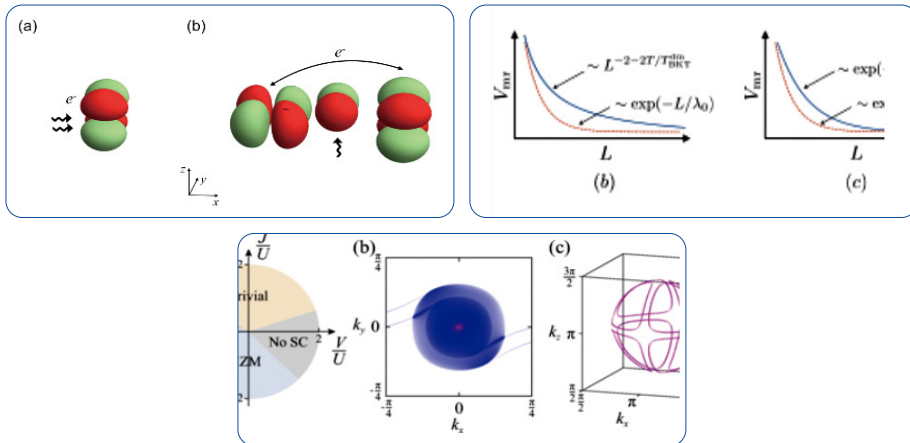

[Superconductivity in quantum paraelectrics, Vortex effect on superconducting spintronics, Superconductivity in topological semimetals]

Recent Publications&Projects

- npj Quantum Materials, "Theory of superconductivity in doped quantum paraelectrics"(2022)
- SciPost Physics Core, "Berezinskii-Kosterlitz-Thouless transition transport in spin-triplet superconductor"(2022)
- Physical Review B, "Topological multiband s-wave superconductivity in coupled multifold fermions"(2021)
- MSIT, Republic of Korea "Natural Science Research Institute"(~2027)

Honors&Awards

- [Award] Outstanding Young Researcher Award, Association of Korean Physicists in America(2013)

Sang-il Kim | 김상일 교수



Department: Department of Materials Science and Engineering

Lab: Advanced Energy Materials Laboratory

Ph.D.: University of Wisconsin–Madison, 2007

Research: Thermoelectricity, 2D Materials

E-mail: sang1.kim@uos.ac.kr

Homepage: campus.uos.ac.kr/aeml

Key Words

Materials Science, Thermoelectrics, Energy Materials, Superconductivity, Thin films

Areas of Research

Thermoelectricity

- Thermoelectricity, Thermoelectric materials, Applied thermoelectric materials

2D Materials Research

- Transition metal dichalcogenide
- Post-transition metal dichalcogenide
- 2D oxide monolayers(TiO₂, RuO₂....)

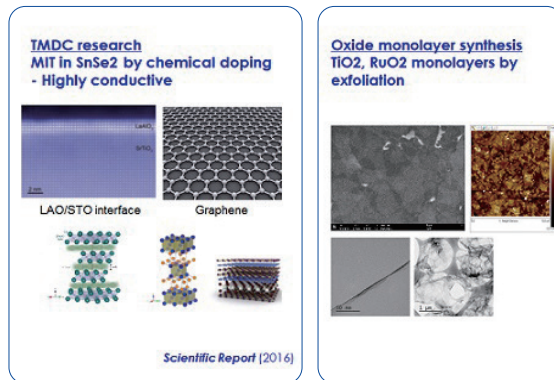

[2D Materials]

Recent Publications&Projects

- Journal of Alloys and Compounds, "Impact of resonant state formation and band convergence in In and Sr co-doped SnTe thermoelectric material evaluated via the single parabolic band model"(2023)
- Solid State Sciences, "Phase formation and thermoelectric properties of FeSe₂-CoSe₂ system"(2023)
- Advanced Functional Materials, "Approach to Determine the Density-of-States Effective Mass with Carrier Concentration-Dependent Seebeck Coefficient"(2022)
- Acta Materialia, "Nanoparticles in Bi_{0.5}Sb_{1.5}Te₃: a prerequisite defect structure to scatter the mid-wavelength phonons between Rayleigh and geometry scattering"(2022)

Honors&Awards

- [수상] 2023년 과총 제33회 과학기술우수논문상

Hyun-Sik Kim | 김현식 교수



Department: Department of Materials Science and Engineering

Lab: Electronic Materials Engineering Laboratory

Ph.D.: California Institute of Technology, 2016

Research: Ceramic materials

E-mail: hyunsik.kim@uos.ac.kr

Homepage: emelab.uos.ac.kr

Key Words

Dielectric material, Thermoelectric materials

Areas of Research

Dielectric materials

- Core/shell nanostructure engineering(BaTiO₃-, SrTiO₃-based core/shell)
- Selective diffusion length engineering(shell composition gradient control)
- Surface defect engineering(nucleation growth control)

Thermoelectric materials

- Phonon engineering(atomic-scale defect, nanoparticle, dislocation)
- Band engineering(band flattening, band convergence, band hybridization, carrier tuning)

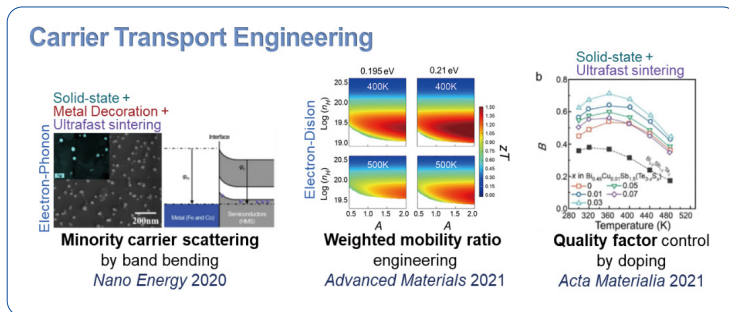

[Carrier transport engineering for thermoelectric performance improvement]

Recent Publications&Projects

- Advanced Functional Materials, "Approach to Determine the Density-of-States Effective Mass with Carrier Concentration-Dependent Seebeck Coefficient"(2022)
- Advanced Materials, "Weighted mobility ratio engineering for high-performance Bi-Te-based thermoelectric materials via suppression of minority carrier transport"(2021)
- ACS Energy Letters, "More than 9% efficient ZnSeTe quantum dot-based blue electroluminescent devices"(2020)
- Nano Energy, "Synchronized enhancement of thermoelectric properties of higher manganese silicide by introducing Fe and Co nanoparticles"(2020)
- 과기부, "산소 공공 제어 및 실시간 모자이크 표면 생성을 통한 고효율 고온용 산화물 열전발전 소재"(~2027)

Honors&Awards

- [수상] 한국세라믹학회 대주신진과학자상(2021)

Jinhwan Yoon | 윤진환 교수



Department: Chemical Engineering

Lab: Soft Materials and Devices Laboratory

Ph.D.: POSTECH, 2007

Research: Deformable Optoelectronic devices

E-mail: jyoong@uos.ac.kr

Homepage: yoongroup.net

Key Words

Ionic hydrogels, deformable devices, wearable devices, strain sensor, supercapacitors

Areas of Research

With mechanically reinforced tough soft materials, our lab developed a highly transparent and deformable electrode for optoelectronic devices such as electroluminescence, energy generators, supercapacitors and soft optical fibers.

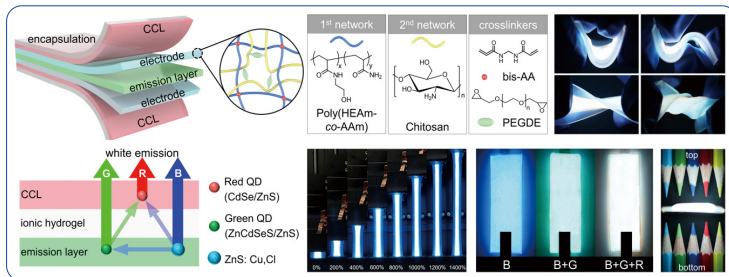

[Deformable optoelectronic devices]

Recent Publications&Projects

- Small, "Bright Bifacial White-Light Illumination by Highly Deformable Electroluminescent Devices Based on Transparent Ionic-Hydrogel Electrodes and Quantum-Dot Color Conversion"(2024)
- Advanced Science, "Seamless integration of conducting hydrogels in daily life: from preparation to wearable application"(2024)
- Advanced Functional Materials, "Optically Transparent and Mechanically Robust Ionic Hydrogel Electrodes for Bright Electroluminescent Devices Achieving High Stretchability over 1400%"(2023)
- Advanced Functional Materials, "Smart skin-adhesive patches: From design to biomedical applications"(2023)
- Chemical Engineering Journal, "Self-adhesive thermotropic smart films for adaptive solar control under various climate conditions"(2022)
- 과기부, "분자 간 상호작용 제어를 통한 기계적 물성 가변형 연성소재"(~2026)
- 과기부, "태양광에너지 지속가능 활용 연구센터"(~2025)
- 삼성전자, "분자스위치 타이머를 활용한 초고선형동적범위 이미지 센서의 개발"(~2023)

Honors&Awards

- [수상] 교육부 학술연구지원사업 우수성과 50선(2023)
- [수상] 도레이중견학술상, 한국고분자학회(2023)
- [수상] 기초연구진흥 유공 과학기술정보통신부 장관 표창(2021)

Dahin Kim | 김다흰 교수



Department: Department of Chemical Engineering
Lab: Advanced Semiconductor Nanomaterials Laboratory
Ph.D.: Korea Advanced Institute of Science&Technology, 2018
Research: Semiconductor Nanomaterials
E-mail: dhkim23@uos.ac.kr
Homepage: sites.google.com/view/dhkimlab

Key Words

Quantum dots, Anisotropic semiconductor nanomaterials, Colloidal synthesis, Optical properties, Display

Areas of Research

Our research group focuses on developing semiconductor nanomaterials. We strive to deepen our understanding of the fundamental science behind semiconductor technology, nanotechnology, and optical physics. Ultimately, our goal is to create innovative semiconductor nanomaterial systems for use in applications such as displays, energy, environmental technologies, and biotechnology.

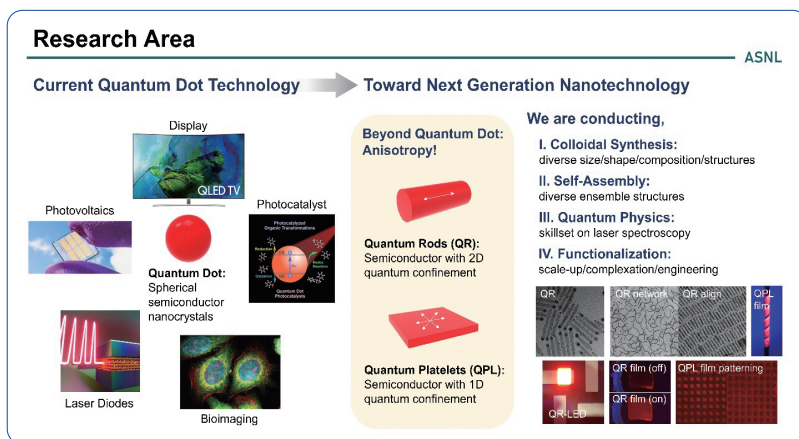

[Anisotropic semiconductor nanomaterials: alternatives to quantum dots]

Recent Publications&Projects

- ACS Nano, "Uniaxial Strain Engineering via Core Position Control in CdSe/CdS Core/Shell Nanorods and Their Optical Response"(2022)
- Nature Communications, "Dynamic Magnetic Field Alignment and Polarized Emission of Semiconductor Nanoplatelets in a Liquid Crystal Polymer"(2022)
- Journal of Physical Chemistry Letters, " Surface Ligands as Permeation Barrier in the Growth and Assembly of Anisotropic Semiconductor Nanocrystals"(2020)
- 과기부, "태양광 집광효율 한계 돌파를 위한 직진성 발광 양자구조체 복합필름 개발"(~2029)

Honors&Awards

- [수상] 삼성 양자점 포럼, 최우수상(2017)
- [수상] 국제양자점학회 Journal of the American Chemical Society Award(2016)

Jong Woo Lee | 이종우 교수



Department: Applied Chemistry

Lab: Microspectroscopy Convergence Analysis Laboratory

Ph.D.: Seoul National University, 2017

Research: Microspectroscopy, Carrier Dynamics

E-mail: promise@uos.ac.kr

Homepage: <https://sites.google.com/view/promiselab>

Key Words

Micro-spectroscopy, Dynamics, Fluorescence lifetime imaging, Raman imaging, Fluorescence imaging, Photocurrent mapping, Perovskite, Nanoparticle

Areas of Research

- **Raman Spectroscopy:** Effective for analyzing the crystallinity of semiconductor materials, as well as defects, contaminants, and chemical compositions.
- **Fluorescence Lifetime Analysis:** A non-destructive technique that is sensitive to environmental factors such as temperature, chemical surroundings, and electric fields, providing information about charge carrier dynamics.
- **Combined with Microscopy:** Offers spatial information and is effective for assessing compositional variance and the distribution of defects or amorphous characteristics.

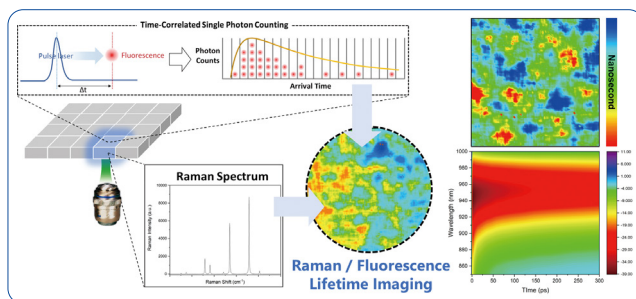

Recent Publications&Projects

- ACS Energy Letters, "Harnessing Strong Band-Filling in Mixed Pb-Sn Perovskites Boosts the Performance of Concentrator-Type Photovoltaics"(2023)
- Advanced Science, "Ultrasensitive Near-Infrared Circularly Polarized Light Detection Using 3D Perovskite Embedded with Chiral Plasmonic Nanoparticles"(2022)
- Energy & Environmental Science, "Abnormal Spatial Heterogeneity Governing Charge-Carrier Mechanism in Efficient Ruddlesden-Popper Perovskite Solar Cells"(2021)
- Chemical Communications, "Sub-nanoscale Probing of Nanojunction using Heterogeneous Gap-Mode Raman Spectroscopy"(2020)
- Journal of the American Chemical Society, "Highly Crystalline Perovskite-based Photovoltaics via Two-dimensional Liquid Cage Annealing Strategy"(2019)

Honors&Awards

- [수상] 2023년 우수강의교수상(2024)
- [수상] Young Scientist Award(15th KPPS)



Process

No.	Faculty	Department
8	Jung Hyeun Kim	Department of Chemical Engineering
9	Ohsung Song	Department of Materials Science and Engineering
10	Jae Pil Jung	Department of Materials Science and Engineering
11	Byung Jun Jung	Department of Materials Science and Engineering
12	Hyosun Lee	Department of Materials Science and Engineering
13	TaeWan Kim	School of Advanced Fusion Studies
14	Seongah Jeong	School of Advanced Fusion Studies

Jung Hyeun Kim | 김정현 교수



Department: Department of Chemical Engineering

Lab: Nanosystem Applications Laboratory

Ph.D.: University of Maryland, College Park, 2003

Research: Photocatalyst

E-mail: jhkimad@uos.ac.kr

Homepage: sites.google.com/view/uosnsal

Key Words

Polyurethane foam, Photocatalyst, Photoelectrochemical cell, Shape memory elastomer

Areas of Research

Polyurethane foam Seat pad

- Polyurethane foams(PUF) has a good formability and light weight, and are widely used in various industries such as automobiles.

Polyurethane foam Sound absorption material

- Flexible polyurethane(FPU) foams are widely used as sound absorption materials of automobiles because of the light weight, ease of production and high sound absorption efficiency

Photocatalyst, Photoelectrochemical cell

- Photocatalyst materials for photochemical hydrogen production through water splitting under the sunlight

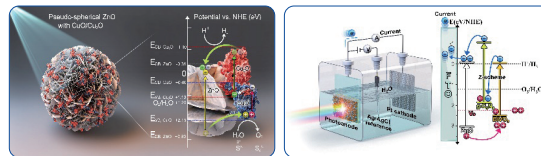

[Photocatalyst(left), Photoelectrochemical cell(right)]

Shape memory elastomer

- It has the ability to fix a temporarily deformed shape and recover its original shape through external stimuli.

Recent Publications&Projects

- Journal of Environmental Chemical Engineering, "Hydrothermal synthesis of the CdS nanorods on electrochemically deposited Fe₂O₃ thin film for improving photoelectrochemical performance"(2023)
- Polymer Testing, "Performance evaluations of flexible polyurethane foams manufactured with castor oil-based bio-polyol"(2023)
- Applied Surface Science, "Hierarchically interconnected g-C₃N₄/BiVO₄/ZnO arrays via spin coating for high photoelectrochemical performance"(2022)
- Green Energy & Environment, "High Performance of TiO₂/Cu₂O Photoelectrodes for Regenerative Solar Energy Storage in a Vanadium Photoelectrochemical Cell"(2022)
- 과기부, "전하 분리 효율화 광촉매 개발 및 광전기화학적 에너지 저장"(~2024)

Honors&Awards

- [Award] 학술연구지원사업 우수성과 50선 교육부장관 표창(2022)

Ohsung Song | 송오성 교수



Department: Department of Materials Science and Engineering

Lab: Information Materials Laboratory

Ph.D.: Massachusetts Institute of Technology, 1994

Research: Solar Cells, Semiconductor Processing, Precious Metal Recovery, Diamond Related Materials

E-mail: songos@uos.ac.kr

Homepage: campus.uos.ac.kr/songos

Key Words

Solar Cells, Semiconductor Processing, Precious Metal Recovery, Diamond Related Materials

Areas of Research

Semiconductor Process

- From photo process specialization to advanced packaging process, Plasma etching process

Energy Conversion Efficiency enhancement for Perovskite Solar Cells

Precious Metal Group, Ruthenium/Iridium/Palladium, Recovery Process

Diamond Growing with MP CVD and HPHT

Large diameter Diamond Substrate

Diamond Characterization

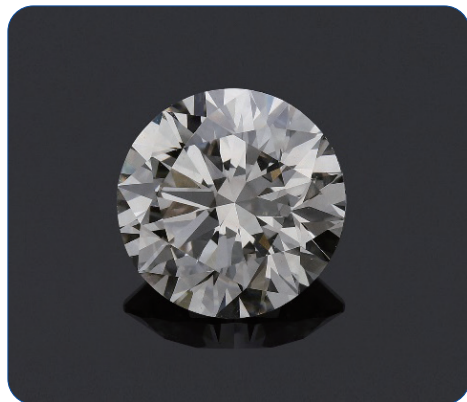
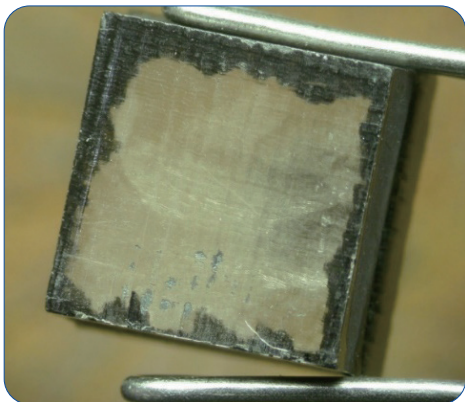

[A10mm single crystal diamond substrate(left), 1.27ct brilliant cut diamond(right)]

Recent Publications&Projects

- Journal of Asian Ceramic Societies, "Propertise of foamed glass upon addition of polysiloxane"(2020)
- Journal of Asian Ceramic Societies, "Properties of basalt-fiber reinforced foam glass"(2020)
- Journal of Asian Ceramic Societies, "Properties of foamed glass upon addtion of nanocarbon and sintering temperatures"(2020)

Honors&Awards

- [기술이전] 합성다이아몬드의 제조와 감별기술(2021), Getter를 이용한 가스 정화 기술(2020)
- [표창] 중소기업 기술혁신 유공자 산업통상자원부장관상(2016)
- [표창] 산학협력력부문 서울지방중소기업청장 표창장(2016)

Jae Pil Jung | 정재필 교수



Department: Department of Materials Science and Engineering

Lab: Micro Joining&Semiconductor Packaging Laboratory

Ph.D.: Seoul National University, 1992

Research: Semiconductor packaging, Micro Joining

E-mail: jujung@uos.ac.kr

Homepage: sites.google.com/view/uosmjlab

Key Words

Soldering, Brazing, Micro-joining, Electroplating, Packaging

Areas of Research

- Soldering and Pb-free solders, Packaging
- Brazing, Micro-joining process
- Electro-/ Electroless plating

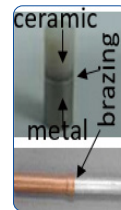
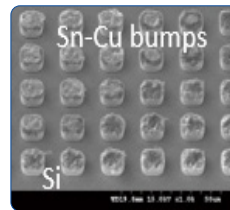
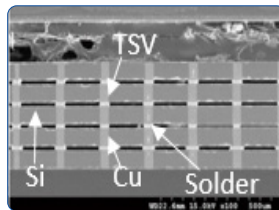
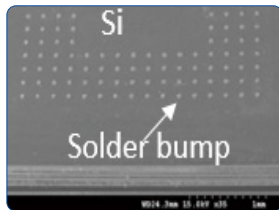

[Soldering, Brazing, Plating, Packaging, Flexible nano-heater]

Recent Publications&Projects

- Journal of Electronic Materials, "Intermediate Low-Melting-Temperature Solder Thermal Cycling Enhancement Using Bismuth and Indium Microalloying"(2023)
- Journal of Materials Science: Materials in Electronics, "Investigating the physical, mechanical, and reliability study of high entropy alloy reinforced Sn-3.0Ag-0.5Cu solder using 1608 chip capacitor/ENIG joints"(2022)
- Journal of Materials Engineering and Performance, "Ultrasonic-Assisted Dispersion of ZnO Nanoparticles to Sn-Bi Solder: A Study on Microstructure, Spreading, and Mechanical Properties"(2021)
- Metals and Materials International, "Recent Advances in Active Metal Brazing of Ceramics and Process"(2020)
- 산업부, "수송기기용 고강도 경량 소재 표면처리 시생산 기반 구축"(~2025)
- 산업부, "미니-LED 미세전극 접합을 위한 도전성 나노소재 기술 개발"(~2024)

Honors&Awards

- [표창] 중소벤처기업부 장관 표창(2023)
- [수상] KISWEL Award 대한용접접합학회(2023)
- [수상] 영국 왕립공학학술원 (Royal Academy of Engineering) Distinguished Visiting Fellowship(2017)
- [수상] 학술상 대한용접접합학회(2015)
- [수상] Highly Commended Award Emerald LiteratiNetwork (UK)(2013)
- [수상] 공학한림원 산업부 2020년 대한민국 미래 100대 기술과 주역- 3차원 패키징(2013)
- [기업 기술이전] 무연솔더, 브레이징 합금, 면상발열체, 고순도 도금액 등 다수

Byung Jun Jung | 정병준 교수



Department: Department of Materials Science and Engineering

Lab: Organic Electronics Materials Laboratory

Ph.D.: Korea Advanced Institute of Science & Technology, 2004

Research: Polymer material, Display process & devices

E-mail: jungbj@uos.ac.kr

Homepage: campus.uos.ac.kr/osc

Key Words

Polymer material, Display process & devices, Organic electronics, OLED, Photolithography

Areas of Research

The research of OEM group is focused on organic electronics such as OLED and OTFT. From materials to devices, we are studying the relationship between molecular structure and electrical performance. Currently, we are developing new photolithography process for OLED pixel patterning. Also, we have investigated EUV photoresist patterns.

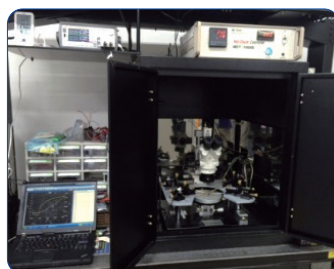

[Organic Electronics Materials Laboratory Equipment]

Recent Publications&Projects

- ACS Applied Polymer Materials, "Photoinduced Solubility Modulation in the Copolymers of Fluoroalkyl, Spiropyranyl, and Isobornyl Methacrylates"(2023)
- Dyes and Pigments, "Efficient TADF from carbon-carbon bonded donor-acceptor molecules based on boron-carbonyl hybrid acceptor"(2023)
- SPIE Proc., "Fluoroalkylated tin-oxo nano clusters as resist candidates for extreme UV lithography"(2023)
- Polymer Chemistry, "Photo-cleavable perfluoroalkylated copolymers for tailoring quantum dot thin films"(2020)
- Micromachines, "Two-Color Pixel Patterning for High-Resolution Organic Light-Emitting Displays Using Photolithography" (2020)
- Microelectronic Engineering, "Descumming fluorous solution for photolithographic patterning of organic light-emitting diodes"(2020)
- 산업통상자원부, "리소그래피(Lithography) 공정에 의한 OLED 화소 형성 기술 개발"(2000~2024)
- 삼성미래기술육성사업, "극자외선 리소그래피 (EUVL)용 레지스트 및 적용공정 개발"(2021~2024)

Honors&Awards

- [기술이전] 고불소화 포토레지스트와 이를 이용한 유기전자소자의 제조방법(2023)
- [수상] International Meeting on Information Display (IMID 2022) 우수 포스터 논문상(2022)

Hyosun Lee | 이효선 교수



Department: Department of Materials Science and Engineering

Lab: Advanced Nanomaterials for Energy Conversion Laboratory

Ph.D.: Korea Advanced Institute of Science&Technology, 2017

Research: Analysis of surface and interface in semiconductor processing

E-mail: hyosunlee@uos.ac.kr

Homepage: www.anec.uos.ac.kr

Key Words

Nanoparticle, Interfacial effect, Surface composition, 3D support structure, Selective reaction, Liquid phase reaction

Areas of Research

- Metal nanoparticles on oxide support
- Hollow oxide nanoreactors
- Nanoporous metal with oxide
- Single atom catalysts
- Oxide heterostructures
- Inorganic-organic hybrid porous materials
- Photo-thermal reaction system
- Photocatalysis

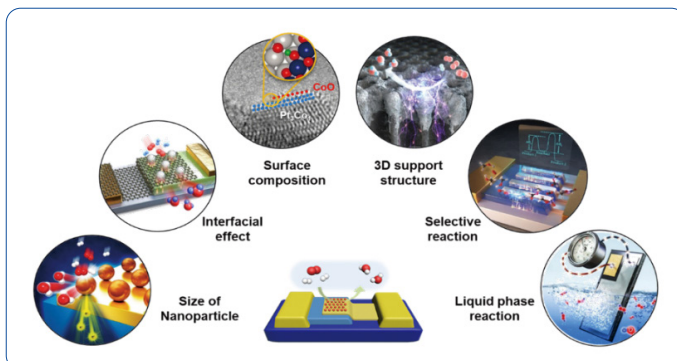

[Advanced Nanomaterials for Energy Conversion Laboratory Research Theme]

Recent Publications&Projects

- The Journal of Physical Chemistry Letters, "Hot Electron Phenomena at Solid-Liquid Interfaces"(2022)
- Nature Communications, "Controlling hot electron flux and catalytic selectivity with nanoscale metal-oxide interfaces"(2021)
- ACS Catalysis, "Dilute Pd/Au Alloys Replace Au/TiO₂ Interface for Selective Oxidation Reactions"(2020)
- 과기부, "미세플라스틱 응집 및 제거를 위한 친환경/고성능 마이크로 모터 시스템 개발"(~2024)

Honors&Awards

- Joined the Editorial board of the journal "Surface Science and Technology"(2023)

TaeWan Kim | 김태완 교수



Department: School of Advanced Fusion Studies
Lab: Advanced Materials and Nano-electronic Device Laboratory
Ph.D.: University of Wisconsin - Madison, 2014
Research: MOCVD Growth and Process, Nano-electronic Device
E-mail: twkim@uos.ac.kr
Homepage: <https://sites.google.com/site/amndlaboratory18/>

Key Words

MOCVD growth, Nano-scale Semiconductor Process and Device, Nano-Optoelectronic devices

Areas of Research

The creation of advanced materials and their related processes in the future electronics industry has led to many innovations. Enhancements in electronic device performance can be directly linked to advances in material growth and fabrication development. Our research mainly focus on materials growth and fabrication issues for electronic devices including low power consumption and high mobility FET, opto-electronic devices, and sensors.

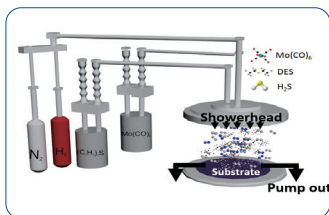

[MOCVD growth of 2D TMDs]

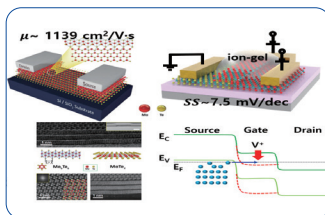

[Next-generation Nano-electronic Device]

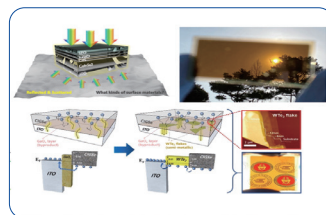

[Ultra-thin Semi-transparent Solar cell]

Recent Publications&Projects

- Small, "Application of bifacial semitransparent CuInSe2 absorber to the bottom cell in bifacial semitransparent perovskite/CuInSe2 tandem solar cell for albedo environment"(2024)
- ACS Applied Materials & Interfaces, "Compositionally Graded MoS2xTe2(1-x)/MoS2 Van der Waals Heterostructures for Ultra-Thin Photovoltaic Applications"(2024)
- ACS Applied Electronic Materials, "Ultralow Subthreshold-swing 2D/2D Heterostructure Tunneling Field-effect Transistor with Ion-gel Gate Dielectrics"(2023)
- Advanced Optical Materials, "Optical soldering of MoS2 layers for defect structure formation with induced photoluminescence"(2022)
- ACS Nano, "van der Waals Epitaxy of High mobility Polymorphic structure of Mo6Te6 nano plates/MoTe 2 Atomic Layers with Low Schottky barrier height"(2019)
- 과기부, "유기금속 화학기상증착법을 이용한 웨이퍼 스케일 이차원 구조 다원화합물 전이금속 디칼코게나이드계 성장 및 차세대 전자소자 응용 기술 개발" (~2024)
- 삼성전자DS, "이차원소재 상변이제어 기반 Polymorphic 구조를 이용한 고성능 차세대 소자 개발" (~2025)
- 과기부, "극한결함제어를 통한 우주환경극복 고성능 와이드밴드갭 반도체 개발" (~2027)

Honors&Awards

- [수상] 전북대학교 연구부분 동행상 수상(2023)
- 한국진공학회 운영위원 및 반도체 및 박막 분과/플라즈마 분과 위원
- ICMAP 조직위원회

Seongah Jeong | 정성아 교수



Department: School of Advanced Fusion Studies

Lab: Ubiquitous and intelligent communications (Unicon) Lab

Ph.D.: KAIST, 2015

Research: 6G, IoT, aerospace&vehicular communications

E-mail: seongah@uos.ac.kr

Homepage: <https://sites.google.com/view/uniconlab>

Key Words

Wireless communications, edge computing, radar sensing, wireless localization, optimization

Areas of Research

Ubiquitous and intelligent communications (Unicon) Lab carries out advanced and strategic research on academic and technological fronts in next-generation wireless and mobile communications. We develop state-of-the-art technologies by exploiting methodologies grounded on advanced analytical tools in information theory, optimization theory, statistics and probability theory, graph theory, matrix theory as well as advanced learning tools. We find our applications to the ubiquitous and intelligent communications via edge & cloud computing, aerospace & vehicular communications, wireless power transfer and physical-layer security technologies.

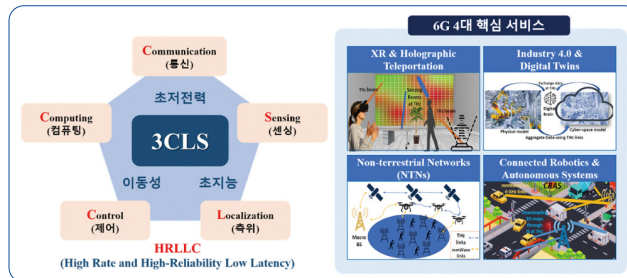

Recent Publications&Projects

- IEEE IoT Journal, "Energy-Efficient Secure Offloading System Designed via UAV-Mounted Intelligent Reflecting Surface for Resilience Enhancement"(2024)
- IEEE IoT Journal, "Cache-assisted Mobile Edge Computing over Space-Air-Ground Integrated Networks for Extended Reality applications"(2024)
- IEEE IoT Journal, "Marine IoT Systems with Space-Air-Sea Integrated Networks: Hybrid LEO and UAV Edge Computing"(2023)
- IEEE Trans. Vehicular Technology, "Mobile Edge Computing via a UAV-Mounted Cloudlet: Optimization of Bit Allocation and Path Planning"(2018)
- NRF, "Pre-6G/6G 핵심 기술 확보를 위한 통신/컴퓨팅/제어/측위/센싱(3CLS) 혁신 기술 개발"(~2028)
- IITP, "초지능 서비스를 위한 통신/컴퓨팅 융합혁신기술개발"(~2027)

Honors&Awards

- IEEE Vehicular Technology Society 2021 Jack Neubauer Memorial Award
- Silver, the 21st Samsung Human Tech Paper Award
- Bronze, the 20th Samsung Human Tech Paper Award
- IEEE Senior Member

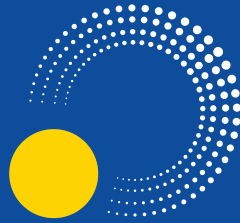

Device

No.	Faculty	Department
15	Dong-Wook Park	School of Electrical and Computer Engineering
16	Hyeok Kim	School of Electrical and Computer Engineering
17	Yoon Kim	School of Electrical and Computer Engineering
18	Jung Hwa Seo	Department of Physics
19	Myounggon Kang	School of Advanced Fusion Studies
20	TaeWan Kim	School of Advanced Fusion Studies
21	Sin-Hyung Lee	School of Advanced Fusion Studies

Dong-Wook Park | 박동욱 교수



Department: School of Electrical and Computer Engineering

Lab: Bio-Nano Electronics Laboratory

Ph.D.: University of Wisconsin-Madison, 2015

Research: Biomedical devices and biosensors

E-mail: dwpark31@uos.ac.kr

Homepage: bionano.uos.ac.kr

Key Words

Biomedical devices, Biosensors, Transparent Neural electrode, Flexible and Stretchable Devices, DNA Aptamer Sensors

Areas of Research

- The BNEL is a professional academic who believes in in-depth research and hands-on teaching. Drawing from thorough academic training and extensive research experience, we develop emerging biomedical devices and systems using novel materials and nanotechnologies
- Emerging biomedical devices and biosensors using novel materials and nanotechnology, flexible electronics, neuromorphic devices, and field-effect transistors integrated in microfluidics

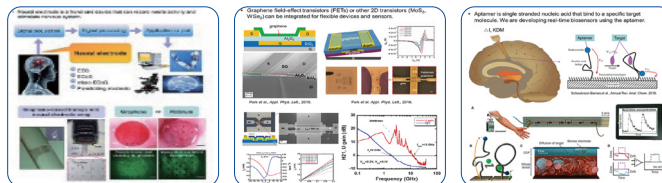

[Transparent Neural electrode(left), Flexible and Stretchable Devices(center), DNA Aptamer Sensors(right)]

Recent Publications&Projects

- Journal of Semiconductor Technology and Science, "Development of Organic Thin-film Transistors on a Biocompatible Parylene-C Substrate"(2023)
- IEEE Electron Device Letters, "Physics-based compact model of current stress-induced threshold voltage shift in top-gate self-aligned amorphous InGaZnO thin-film transistors"(2022)
- Applied Physics Letters, "Trench field-effect transistors integrated in a microfluidic channel and design considerations for charge detection"(2022)
- ACS Nano, "Electrical neural stimulation and simultaneous in vivo monitoring with transparent graphene electrode arrays implanted in GCaMP6f mice"(2018)
- 과기부, "고성능 고신뢰성 생체이식형 유기 하이브리드 투명 바이오전극 개발"(~2024)
- 산업부, "차세대시스템반도체설계전문인력양성사업"(~2026)
- 과기부, "지능형 사물 에너지 (iEoT) 반도체 시스템 융합 다빈치형 인력양성센터"(~2026)

Honors&Awards

- [기술이전] 뇌 심부 자극 투명 전극 어레이 및 이를 이용한 신경 신호 검출 방법(2021)
- [수상] 서울시립대학교 우수강의교수상(2017, 2018, 2019, 2021)
- [수상] 반도체학술대회 우수 포스터 논문상(2022)
- [수상] 한국전기전자학회 우수 포스터 논문상(2021)

Hyeok Kim | 김혁 교수



Department: School of Electrical and Computer Engineering

Lab: Display&Flexible Electronics Laboratory

Ph.D.: CNRS&U. Paris 7, 2015

Research: Semiconductor devices

E-mail: hyeok.kim@uos.ac.kr

Homepage: nobel.uos.ac.kr

Key Words

Semiconductor devices (diode, transistor), Display/sensor/energy semiconductor devices

Areas of Research

- Display Optoelectronics(TFT for OLED/QLED, Perovskite LED)
- Bioelectronics(Artificial Skin, Biosensor, Biochip)
- Advanced Nano Semiconductor Device
- Flexible Nanoelectronics
- Eco-friendly Energy Device(Energy Harvesting, Solar Cell)



[Solar Panel(left), Flexible Display(center), Convergent Sensors(right)]

Recent Publications&Projects

- Advanced Functional Materials, "Surface Reconstruction of Ni-Fe Layered Double Hydroxide Inducing Chloride Ion Blocking Materials for Outstanding Overall Seawater Splitting"(2023)
- Solar RRL, "Top-Gate Field Effect Transistor as a Testbed for Evaluating the Photostability of Organic Photovoltaic Polymers"(2022)
- Advanced Energy Materials, "Rational Design of Highly Efficient Semi-Transparent Organic Photovoltaics with Silver Nanowire Top Electrode via 3D Optical Simulation Study"(2021)
- Advanced Materials Interfaces, "Universal Elaboration of Al-Doped TiO₂ as an Electron Extraction Layer in Inorganic-Organic Hybrid Perovskite and Organic Solar Cells"(2020)
- 과기부, "초민감 증폭형 유기 및 페로브스카이트 광센서 연구와 이를 활용한 트랜지스터 어레이 집적회로 개발"(~2026)
- 과기부, "고유연성 폴리머 기반 고민감도 촉각센서 개발"(~2023)

Honors&Awards

- [기술이전] 유연성 압력센서를 포함하는 스마트 장갑(2020), 절전형 나노 에너지 하베스터 외 2건(2020), 자가충전형 저전력 광센서 제조 기술(2020)

Yoon Kim | 김윤 교수



Department: School of Electrical and Computer Engineering

Lab: Advanced Semiconductor Device&Circuit Laboratory

Ph.D.: Seoul National University, 2012

Research: Semiconductor Transistor

E-mail: yoonkim82@uos.ac.kr

Homepage: yoonkim82.wixsite.com/asdl

Key Words

Nano-scale Semiconductor Transistor, Nano-scale Semiconductor Transistor, Neuromorphic Device and System

Areas of Research

Semiconductors are called rice in the electronics industry.. Semiconductor-based transistors are used as core components in all electronic products we use. We are conducting research on the design, manufacturing and analysis of next-generation semiconductor devices and circuits.

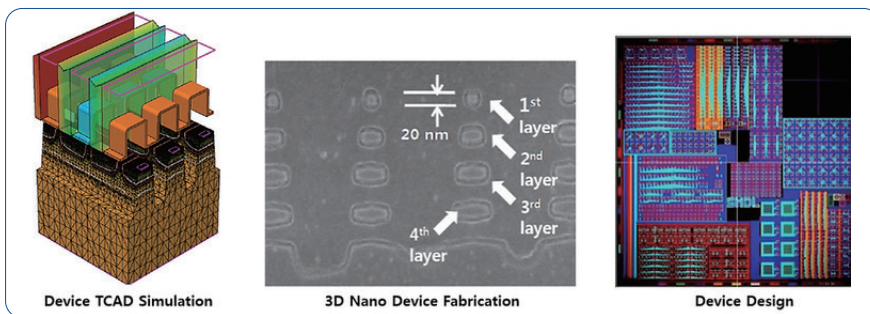

[Nano-scale Semiconductor Transistor]

Recent Publications&Projects

- IEEE Access, "Short- and Long-term Memory Based on a Floating-Gate IGZO Synaptic Transistor"(2023)
- IEEE Transactions on Electron Devices, "Fowler-Nordheim Stress-Induced Degradation of Buried-Channel-Array Transistors in DRAM Cell for Cryogenic Memory Applications"(2022)
- Nano Energy, "Implementation of convolutional neural network and 8-bit reservoir computing in CMOS compatible VRRAM"(2022)
- IEEE Journal of the Electron Devices Society, "NOR-Type Three-dimensional Synapse Array Architecture Based on Charge-Trap Flash Memory"(2022)
- IEEE Access, "Flexible Parylene C-Based RRAM Array for Neuromorphic Applications"(2022)
- 과기부, "전하저장형 메모리 기반 PIM 개발"(~2024)
- 과기부, "실리콘 기반 PIM 특화 소자, 회로, 응용 기술 개발"(~2024)
- 과기부, "인메모리 컴퓨팅 응용을 위한 하이브리드 메모리소자 및 아키텍처 개발"(~2024)

Honors&Awards

- [수상] 제 31회 대한전자공학회 해동젊은공학인상 수상(2021)
- 대한전자공학회(IEEK) 평생회원
- IEEE Member

Jung Hwa Seo | 서정화 교수



Department: Department of Physics
Lab: Nano materials and devices Laboratory
Ph.D.: Yonsei University, 2007
Research: Semiconductor materials and electronic devices
E-mail: seojh@uos.ac.kr
Homepage: sites.google.com/view/lcomofuos

Key Words

Organic Materials, Organic Solar Cells, Organic Transistors, Organic Light-Emitting Transistors, Spectroscopy, Molecular Simulations

Areas of Research

Prof. Jung Hwa Seo is a professor at the Department of Physics in University of Seoul. Her research conducts on organic and inorganic hybrid solar cells, transistors, and light-emitting transistors and photoelectron spectroscopy (x-ray and ultraviolet). Her lab employs a range of experimental techniques such as thin film deposition, device fabrication, and spectroscopy to explore the electrical and optical properties of these materials and their behavior at the nanoscale.

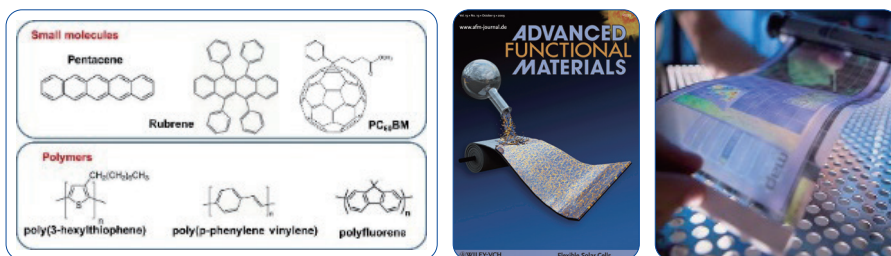

[Organic Materials(left), Organic Solar cells(center), Organic Transistors(right)]

Recent Publications&Projects

- Advanced Materials Interfaces, "Soultion-Processed Metal Ion Polyelectrolytes as Hole Transport Materials for Efficient Inverted Perovskite Solar Cells"(2023).
- Advanced Materials Interfaces, "Improved Hole injection in Hybrid Light-Emitting Transistors Incorporating Lithium and Copper(II) Poly(Styrene Sulfonate)"(2023)
- Journal of Materials Chemistry C, "Highly Efficient Hybrid Light-Emitting Transistors incorporating MoOx/Ag/MoOx Semi-Transparent Electrodes"(2022)
- Applied Surface Science, "Organic cation-polystyrene sulfonate polyelectrolytes as hole transporting interfacial layers in perovskite solar cells"(2022)
- Advanced Functional Materials, "A Simple Cu(II) Polyelectrolyte as a Method to Increase the Work Function of Electrodes and Form Effective p-Type Contacts in Perovskite Solar Cells"(2021)
- 과학부, "이온소재의 도핑 제어를 이용한 유기 homojunction 소자 개발"(~2024)

Honors&Awards

- [수상] 과학기술상 (여성과학자상)(2018)

Myounggon Kang | 강명곤 교수



Department: School of Advanced Fusion Studies

Lab: Device Research Laboratory

Ph.D.: Seoul National University, 2012

Research: Semiconductor Device Modeling & Circuit Design

E-mail: mgkang@uos.ac.kr

Homepage: <https://sites.google.com/view/uos-drl/>

Key Words

Memory Device, Power Semiconductor Device, Circuit Design, (RF) Device Modeling, CMOS Devices and Logic Technology

Areas of Research

- Lateral Migration-based TFT-type Flash Memory
- GaN power device and monolithic control IC technologies
- Physics-based SPICE-compatible compact model of poly-Si TFT-type synapse devices
- Low-power/high-performance 2T DRAM PIM cell, integrated circuits, and architecture

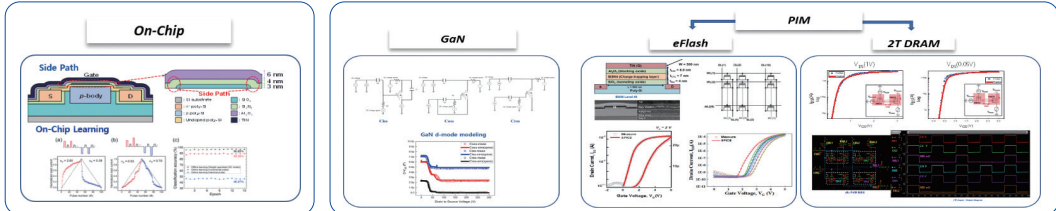

Recent Publications&Projects

- IEEE Access, "Current-Voltage Modeling of DRAM Cell Transistor Using Genetic Algorithm and Deep Learning"(2024)
- IEEE Electron Device Letters, "Selective Erase Operation for Multiple Strings of 3D Ferroelectric (Fe)-NAND Flash Memory"(2024)
- IEEE Access, "Analysis of Logic-in-Memory Full Adder Circuit With Floating Gate Field Effect Transistor (FGFET)"(2023)
- ACS Materials Letters, "Unveiling the Potential of HfO₂/WS₂ Bilayer Films: Robust Analog Switching and Synaptic Emulation for Advanced Memory and Neuromorphic Computing"(2023)
- AIP ADVANCES, "Non-volatile logic-in-memory ternary content addressable memory circuit with floating gate field effect transistor"(2023)
- IEEE Transactions on Electron Devices, "Fowler–Nordheim Stress-Induced Degradation of Buried-Channel-Array Transistors in DRAM Cell for Cryogenic Memory Applications"(2022)
- 과기부, "전하저장형 메모리 기반 PIM 개발"(~2024)
- 과기부, "GaN 전력소자 및 모노리식 구동회로 기술 개발"(~2026)
- 삼성전자, "VNAND 소자 단순 증가 한계 시나리오 및 극복 방안"(~2024)

Honors&Awards

- [수상] 한국반도체산업협회장상(2021), 대한전자공학회 공로상(2019, 2020, 2021), 한국전기전자학회 공로상(2021), IEEE Seoul Section 공로상(2021,2022), 대한전자공학회 논문상(2022)
- IEEE Senior Member

TaeWan Kim | 김태완 교수



Department: School of Advanced Fusion Studies
Lab: Advanced Materials and Nano-electronic Device Laboratory
Ph.D.: University of Wisconsin - Madison, 2014
Research: MOCVD Growth and Process, Nano-electronic Device
E-mail: twkim@uos.ac.kr
Homepage: <https://sites.google.com/site/amndlaboratory18/>

Key Words

MOCVD growth, Nano-scale Semiconductor Process and Device, Nano-Optoelectronic devices

Areas of Research

The creation of advanced materials and their related processes in the future electronics industry has led to many innovations. Enhancements in electronic device performance can be directly linked to advances in material growth and fabrication development. Our research mainly focus on materials growth and fabrication issues for electronic devices including low power consumption and high mobility FET, opto-electronic devices, and sensors.

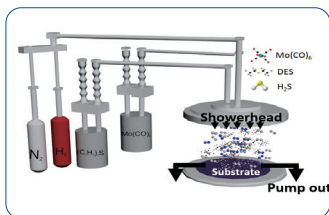

[MOCVD growth of 2D TMDs]

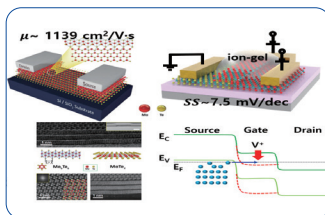

[Next-generation Nano-electronic Device]

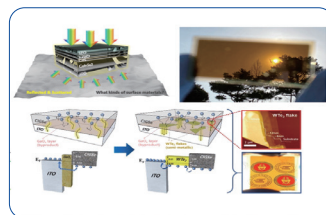

[Ultra-thin Semi-transparent Solar cell]

Recent Publications&Projects

- Small, "Application of bifacial semitransparent CuInSe2 absorber to the bottom cell in bifacial semitransparent perovskite/CuInSe2 tandem solar cell for albedo environment"(2024)
- ACS Applied Materials & Interfaces, "Compositionally Graded MoS2xTe2(1-x)/MoS2 Van der Waals Heterostructures for Ultra-Thin Photovoltaic Applications"(2024)
- ACS Applied Electronic Materials, "Ultralow Subthreshold-swing 2D/2D Heterostructure Tunneling Field-effect Transistor with Ion-gel Gate Dielectrics"(2023)
- Advanced Optical Materials, "Optical soldering of MoS2 layers for defect structure formation with induced photoluminescence"(2022)
- ACS Nano, "van der Waals Epitaxy of High mobility Polymorphic structure of Mo6Te6 nano plates/MoTe 2 Atomic Layers with Low Schottky barrier height"(2019)
- 과기부, "유기금속 화학기상증착법을 이용한 웨이퍼 스케일 이차원 구조 다원화합물 전이금속 디칼코게나이드계 성장 및 차세대 전자소자 응용 기술 개발" (~2024)
- 삼성전자DS, "이차원소재 상변이제어 기반 Polymorphic 구조를 이용한 고성능 차세대 소자 개발" (~2025)
- 과기부, "극한결함제어를 통한 우주환경극복 고성능 와이드밴드갭 반도체 개발" (~2027)

Honors&Awards

- [수상] 전북대학교 연구부분 동행상 수상(2023)
- 한국진공학회 운영위원 및 반도체 및 박막 분과/플라즈마 분과 위원
- ICMAP 조직위원회

Sin-Hyung Lee | 이신형 교수



Department: School of Advanced Fusion Studies
Lab: Bioelectronics & Integrated System Laboratory
Ph.D.: Seoul National University, 2019
Research: Neuromorphic electronics, Wearable electronics, Hardware security devices and systems
E-mail: sinhlee@uos.ac.kr
Homepage: <https://sites.google.com/view/beis-knu>

Key Words

Next-generation memory, Artificial synapse, Wearable smart electronics, Physically Unclonable Functions

Areas of Research

- Our research group is focused on developing new device structures to realize next-generation computing systems, such as neuromorphic processors, smart wearable electronics, and hardware security systems.

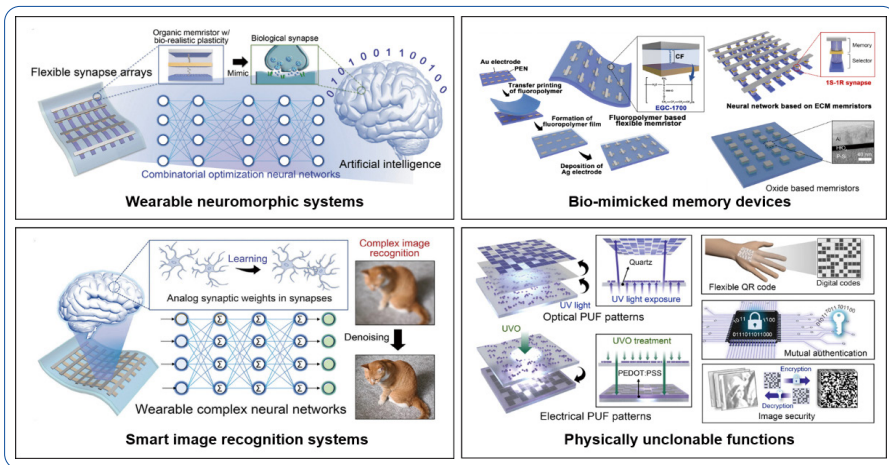

[Research topics in our group]

Recent Publications&Projects

- Advanced Science, "Formation of Cluster-Structured Metallic Filaments in Organic Memristors for Wearable Neuromorphic Systems with Bio-Mimetic Synaptic Weight Distributions"(2024)
- Advanced Science, "Organic Memristor-Based Flexible Neural Networks with Bio-Realistic Synaptic Plasticity for Complex Combinatorial Optimization"(2023)
- npj Flexible Electronics, "Fluoropolymer-based organic memristor with multifunctionality for flexible neural network system"(2021)
- 과기부, "고집적 유연 메모리 어레이 기반의 웨어러블 근전도 신호 인-센서 컴퓨팅시스템"(~2027)
- 과기부, "웨어러블 스마트 이미지 인식 시스템용 유기 소재 기반 아날로그 메모리 소자 및 유연 하드웨어 신경망 원천기술 개발"(~2027)
- 삼성전자, "고성능 선택소자 개발을 통한 고집적 크로스포인트 시냅스 어레이 구현"(~2024)

Honors&Awards

- Joined the Editorial board of the journal "Materials Today Electronics (Elsevier)"(2022)



Circuit

No.	Faculty	Department
22	Joongho Choi	School of Electrical and Computer Engineering
23	Yongsam Moon	School of Electrical and Computer Engineering
24	Moon-Que Lee	School of Electrical and Computer Engineering
25	Seung-Hwan Lee	School of Electrical and Computer Engineering
26	Minsuk Koo	School of Advanced Fusion Studies
27	Min-Jae Seo	School of Advanced Fusion Studies

Joongho Choi | 최중호 교수



Department: School of Electrical and Computer Engineering

Lab: Integrated Circuit Design Laboratory

Ph.D.: University of Southern California, 1993

Research: Analog Integrated Circuit Design

E-mail: jchoi@uos.ac.kr

Homepage: www.iclab02.uos.ac.kr

Key Words

High performance analog filter design, ADC, DAC, Oversampling data converter, PMIC (Power Management IC)

Areas of Research

Analog and mixed-signal integrated circuit design has been studied in this lab since 1998. The main research area is design of high-performance analog front-end (filter and amplifier), analog-to-digital converter, digital-to-analog converter, oversampling data converter, and PMIC (power management IC). Various IC design works and research results are available through many government and industrial projects as well as technical consultants.

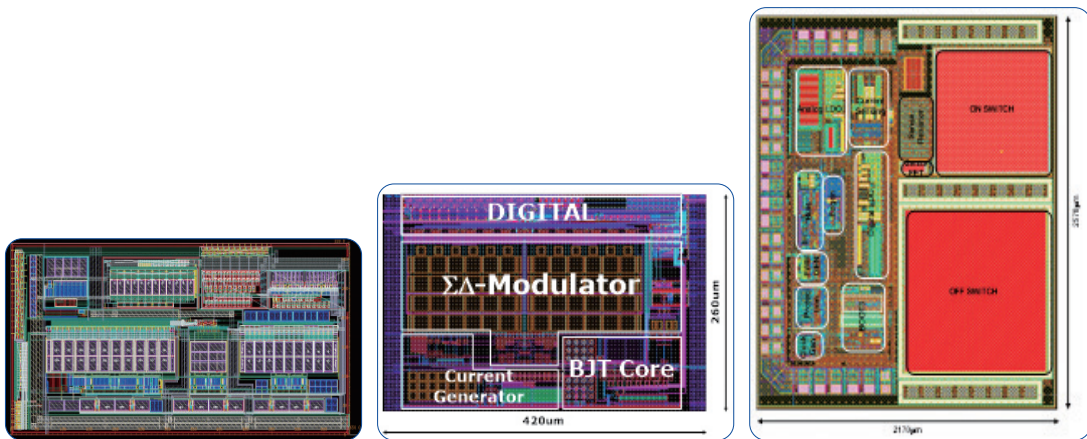

[ADC Communications for IoT(left), H/W performance monitoring sensor(center), Mobile power management IC(right)]

Recent Publications&Projects

- Journal. of Semiconductor Technology and Science, "An 11-bit 50-MS/s Pipelined ADC using Circuit-sharing Techniques" (2019)
- 파두, 전력 손실 방지를 위한 전력 관리 IC 설계(~2024)
- 산업부, "600V급 GaN 소자 집적 고효율 지능형 태양광 에너지 변환 시스템 개발"(~2024)
- 산업부, "차세대 시스템반도체 설계 전문인력 양성사업"(~2026)
- 과기부, "지능형 사물 에너지 (IoT) 반도체 시스템 융합 다빈치형 인력양성센터"(~2026)

Honors & Awards

- [반도체의 날 "근정포장"] 저전력 아날로그, 디지털 변환기 설계자산(IP) 개발, 기술 자문 대통령 근정포장(2022)
- [기술이전] 전력 관리 IC 설계 (2023), 센서용 고효상도 ADC 설계(2020), 모바일 스마트 기기를 위한 전력관리 IC 설계기술(2017), 고효상도 ADC 설계 기술(2017), 센서 응용 저전력 ADC IP 설계 기술(2017)

Yongsam Moon | 문용삼 교수

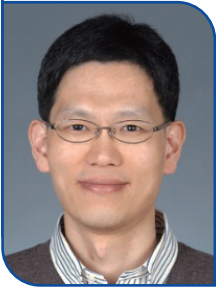

Department: School of Electrical and Computer Engineering

Lab: Integrated Systems Laboratory

Ph.D.: Seoul National University, 2001

Research: Semiconductor Circuit Design

E-mail: ysmoon001@uos.ac.kr

Homepage: campus.uos.ac.kr/isl

Key Words

High-Speed Interface(SATA, PCIe, GE, FC, HDMI) Circuit, Clock and Data Recovery(CDR, PLL) Circuit

Areas of Research

Core Research Areas

- Analog Circuit Design
- Integrated Circuit Design for PC/Network/CE/Storage/Display Systems

Detailed Research Areas

- High-speed interface for chip-to-chip and system-to-system data-communication circuit
- Clock generation circuit based on PLL/DLL(phase-/delay-locked loop)
- Clock and data recovery(CDR) to extract the clean clock and data from distorted data
- Cable Equalizer to compensate for data attenuation caused when passing through a cable



[Integrated Systems Laboratory Equipment]

Recent Publications&Projects

- Journal of Semiconductor Technology and Science, "A 28-nm CMOS 11.2-Gbps Receiver Based on Adaptive CTLE and Adaptive 3-Tap DFE With Hysteresis Low-Pass Filter"(2021)
- 삼성전자, "56-Gbps PAMx Transceiver 설계"(~2024)
- 과기부, "수직 적층 인공지능 플랫폼을 위한 신소재 기반 초고집적 적응형 시냅스 어레이 및 CMOS 집적회로"(~2023)

Honors&Awards

- [발전기여 특별공로상] 서울시립대학교 2023년 대학발전포럼 반도체 분야 특별공로상[2023]
- [기술이전] HD-SDI Transmitter 기술[2018], HD-SDI Phase-Locked Loop 기술[2018], HD-SDI Receiver 기술[2018], HD-SDI Equalizer 기술[2019], HD-SDI Bi-Directional Transceiver 기술[2019]

Moon-Que Lee | 이문규 교수



Department: School of Electrical and Computer Engineering

Lab: Intelligent RF energy center

Ph.D.: Seoul National University, 1999

Research: RF Circuit and System

E-mail: mqlee@uos.ac.kr

Homepage: cafe.naver.com/mwm

Key Words

RF/Microwave energy applications (plasma, heating, and wireless power transfer), RF System Design, RF/mmWave Circuit and System Design, Satellite RF/Microwave payload design

Areas of Research

- RF/Microwave heating system design (RF source, applicator, sensor)
- RF/Microwave generator and V/I sensor for plasma generation
- RF active and passive components design [e.g., Switching-mode power amplifier, auto-matcher, RF/microwave IC, Ceramic Filter/Duplexer, etc.]

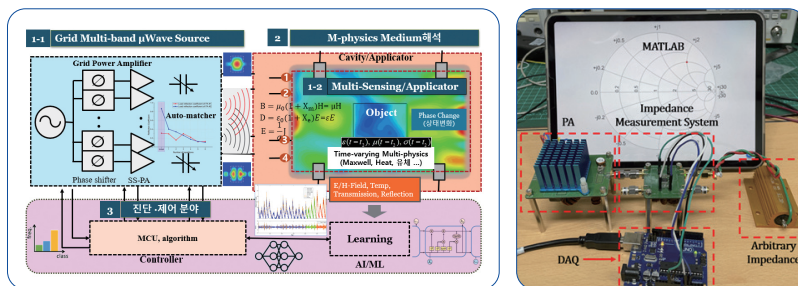

Recent Publications&Projects

- IEEE Access, "High Power Microwave Signal Generation Based on Recursive Balanced Power Amplifier" (2023)
- International Journal of RF and Microwave Computer-Aided Engineering, "Wide E-Plane Beamwidth Microstrip Patch Antenna Using H-Shaped Gap-Coupling with Three Parasitic Patches for the K-Band" (2023)
- 과기부, "ISM 응용을 위한 저능형 마이크로파 에너지 시스템 핵심·원천 기술 개발" (~2030)
- 과기부, "전자기파를 활용한 알츠하이머 치료 기술 연구" (~2025)
- 과기부, "다중 무선 충전을 위한 근역 자기장 성형 기술 개발" (~2025)
- 과기부, "차세대 위성 핵심기술 개발" (~2024)

Honors&Awards

- [수상] The 14th Global Symposium on Millimeter-Waves&Terahertz(GSMM) Best Paper Awards(2022), 제7회 전자파측정 논문경진대회(2022), 제33차 한국전자파학회 정기총회 및 추계학술대회 학술상 수상(2021), IEEE RFID conference Best-paper award(2013)
- [표창] 장관표창(2021)-주파수업무-면허/비면허(2021), 전파산업활성화(2015), 서울지방중소벤처기업청장상(2022)
- [기술이전] 선택적 전력 분배 기능을 갖는 전력 분배기(2021), 근접장 응용을 위한 R F I D 신호 처리 장치(2020), Ceramic Filter/Duplexer (2023)
- 국가주파수심의위원, 비면허 실무위원회 위원, 국가심 ICT융합전문위원 등

Seung-Hwan Lee | 이승환 교수



Department: School of Electrical and Computer Engineering
Lab: Power Electronics & Energy Transfer Systems Laboratory
Ph.D.: University of Wisconsin-Madison, 2013
Research: Power Electronics, Wireless Power Transmission
E-mail: seunghlee16@uos.ac.kr
Homepage: sites.google.com/site/uospeets

Key Words

Power electronics, PMIC thermal and EMI analysis and design, Resonant wireless power transfer system design, High frequency resonant inverter/converter, High frequency magnetic component, Intelligent power electronics transformer

Areas of Research

- Resonant wireless power transfer system design
- High efficiency, high power density converter design
- High-frequency magnetic component (inductor, transformer) design
- High-frequency PV system design
- PMIC thermal management

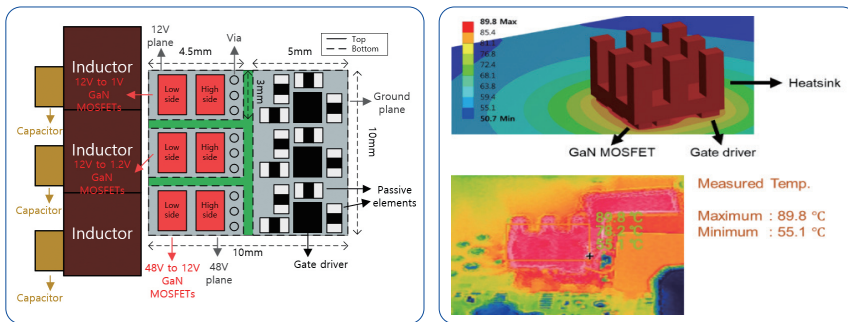

Recent Publications&Projects

- IEEE Trans. on Industrial Electronics, "Sensorless Control of Series-Series Tuned Inductive Power Transfer System"(2022)
- IEEE Trans. on Industry Applications, "A Novel Solid-State Transformer with Loosely Coupled Resonant Dual-Active-Bridge Converters"(2021)
- IEEE Trans. on Industrial Electronics, "Load Voltage and Current Observers for Series-Series Wireless Power Transfer System"(2021)
- 과기부, "중전압(Medium-Voltage)계통 직결위한 Xformerless, Sensorless 멀티레벨 무선전력전송 시스템 연구"(~2025)
- 산업부, "차세대시스템반도체설계전문인력양성사업"(~2026)
- 과기부, "지능형 사물 에너지 (iEoT) 반도체 시스템 융합 다빈치형 인력양성센터"(~2026)

Honors&Awards

- [수상] 2020 IEEE PELS Workshop on Emerging Technologies: Wireless Power Transfer Best Paper Awards(2022)
- [수상] 2021년 우수강의교수상(2022)

Minsuk Koo | 구민석 교수



Department: School of Advanced Fusion Studies

Lab: Advanced Semiconductor Device&Circuit Laboratory

Ph.D.: Purdue University, 2020

Research: Neuromorphic Computing Circuits and System

E-mail: koo@uos.ac.kr

Homepage: yoonkim82.wixsite.com/asdcl

Key Words

Neuromorphic Computing Circuits and System, Process in memory Circuits and System, Stochastic Computing

Areas of Research

- Neuromorphic Computing Circuits and Systems
- Process in Memory Circuits and Systems
- Stochastic Computing Circuits and Systems

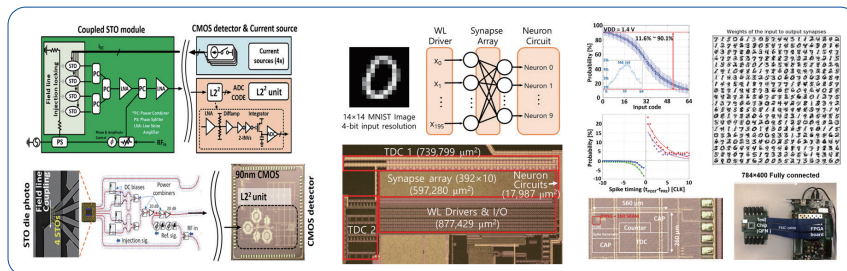

[Neuromorphic Computing(left), Process in Memory(center), Stochastic Computing(right) Circuits and Systems]

Recent Publications&Projects

- Nano Energy, "Implementation of 8-bit reservoir computing through volatile ZrOx-based memristor as a physical reservoir" (2024)
- Physical Chemistry Chemical Physics, "Enhancing simulation feasibility for multi-layer 2D MoS₂ RRAM devices: reliability performance learnings from a passive network model" (2024)
- Advanced Intelligent Systems, "Design of a 180 nm CMOS Neuron Circuit with Soft-Reset and Underflow Allowing for Loss-Less Hardware Spiking Neural Networks" (2024)
- ACS Applied Electronic Materials, "Three-Dimensional Resistive Random-Access Memory Based on Stacked Double-Tip Silicon Nanowires for Neuromorphic Systems" (2024)
- 과기부, "전하저장형 메모리 기반 PIM 개발" (~2024)
- 과기부, "실리콘 기반 PIM 특화 소자, 회로, 응용 기술 개발" (~2024)
- 과기부, "CMOS 로직 공정과 호환 가능한 memcapacitor 소자 및 전압 합산기반 PIM 응용 시스템개발" (~2026)
- 과기부, "신소자 시냅스 및 뉴런 회로 동시 구현을 통한 연결 재구성형 SNN 코어개발" (~2027)

Honors&Awards

- [수상] 인천대학교 학술연구상(2023)
- [수상] 대한전자공학회 공로상(2021) IEEE, IEIE, ISE Member
- IEEE, IEIE, ISE Member

Min-Jae Seo | 서민재 교수



Department: School of Advanced Fusion Studies
Lab: Mixed-signal Circuits and Systems Laboratory
Ph.D.: Korea Advanced Institute of Science and Technology (KAIST), 2019
Research: Mixed-signal & Analog Circuits Design
E-mail: mjseo@uos.ac.kr
Homepage: <https://sites.google.com/view/mcaslab/home>

Key Words

Mixed-Signal Integrated Circuit Design, NAND Flash Readout Circuit Design, Synthesizable Analog Circuits

Areas of Research

The Mixed-Signal Integrated Circuit Laboratory focuses on the design and analysis of integrated circuits that process both analog and digital signals. Our research spans low-power, high-performance systems for applications in communication, sensing, and semiconductor technologies. We aim to innovate in signal processing and mixed-signal circuit architectures for the next generation of electronic systems.

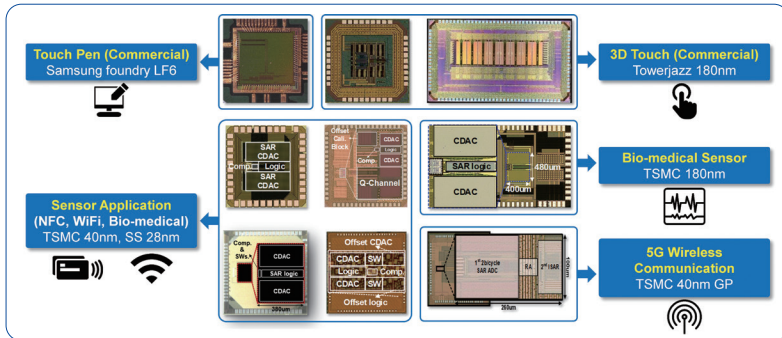

[Chip Photographs]

Recent Publications&Projects

- IEEE Symposium on VLSI Technology and Circuits, "A 100kHz-BW 99dB-DR Continuous-Time Tracking-Zoom Incremental ADC with Residue-Gain Switching and Digital NC-FF"(2024)
- IEEE J. Solid-State Circuits, "A Single-Supply CDAC-Based Buffer-Embedding SAR ADC With Skip-Reset Scheme Having Inherent Chopping Capability"(2020)
- IEEE Symposium on VLSI Circuits, "A 40nm CMOS 12b 200MS/s Single-amplifier Dual-residue Pipelined-SAR ADC"(2019)
- 과기부, "3차원 낸드 플래시 메모리의 셀 고신뢰성 기술 및 소자-회로 통합 테스트베드 플랫폼 개발"(~2026)
- 과기부, "뉴로 칩 설계 기술 및 뉴로 컴퓨팅 플랫폼 연구개발"(~2029)
- 과기부, "초광대역 ADC IP 개발"(~2025)

Honors&Awards

- KAIST 우수연구자상, IDEC 우수신진연구자상
- Technical Program Committee of IEEE A-SSCC
- IEEE Member

UOS RESEARCHER PROFILES

Semiconductor

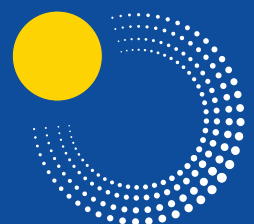
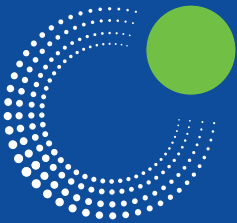
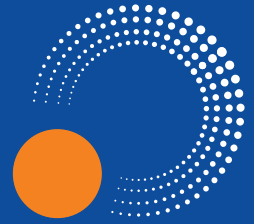

UNIVERSITY OF SEOUL

University of Seoul 163 Seoulsiripdaero, Dongdaemun-gu, Seoul